

# Mini Free Mount Cylinder

## CUJ Series

ø4, ø6, ø8, ø10, ø12, ø16, ø20

RoHS

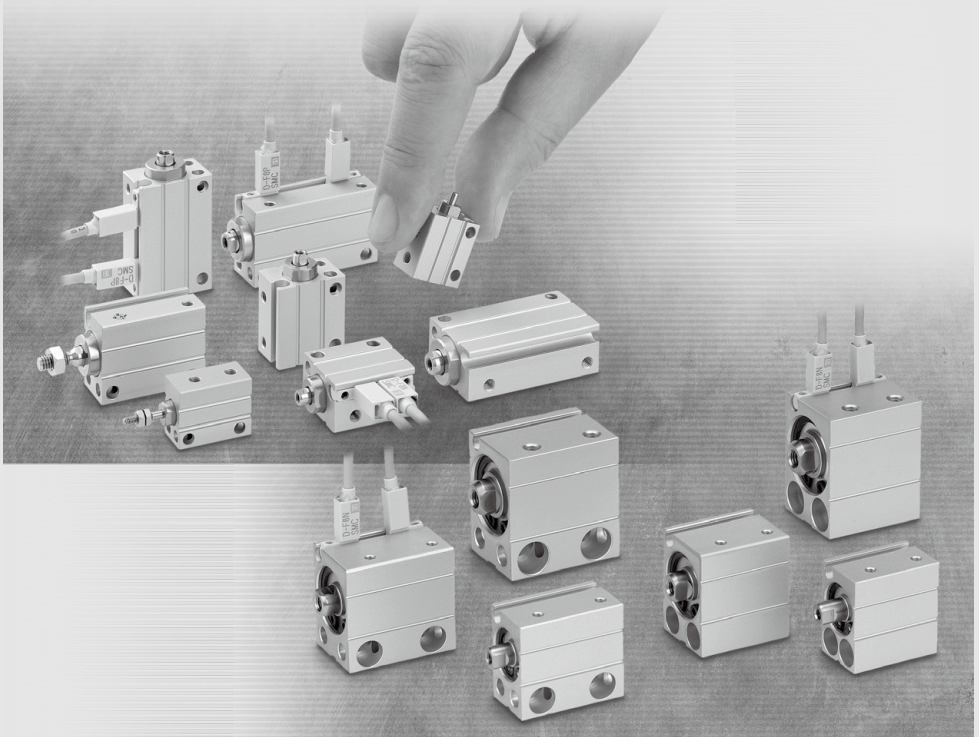

Series	Bore size (mm)	Action	Stroke (mm)													Clean series	Auto switch	Rod end		
			4	5	6	8	10	15	20	25	30	35	40	45	50					
CUJ	4	Double acting	•																None	Male threaded Without thread
		Single acting, spring return																		
	6	Double acting	•																	
		Single acting, spring return																		
	8	Double acting	•																	
		Single acting, spring return																		
	10	Double acting	•																	
		Single acting, spring return																		
	12	Double acting	•																	
		Single acting, spring return																		
	16	Double acting	•																	
		Single acting, spring return																		
	20	Double acting	•																	
		Single acting, spring return																		

## Miniature Body

- Full length is shortened by up to approx. **20%**.
- Volume is reduced by up to approx. **45%**.

(Compared with the CQS series cylinders, double acting, with magnet)

### Dimensions (With Magnet) (mm)

Bore size (mm)	A(a)	B(b)	C(c)
12	17(25)	26.5(25)	19.5(22)
16	21(29)	29.5(29)	21(22)
20	25(36)	36(36)	23.5(29.5)

( ) : Dimensions of the CQS series cylinders

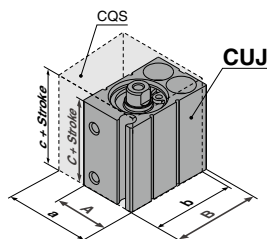

- Full length is shortened by up to approx. **64%**.
- Volume is reduced by up to approx. **70%**.

(Compared with the CU series cylinders, double acting, without magnet)

### Dimensions (Without Magnet) (mm)

Bore size (mm)	A(a)	B(b)	C(c)
4	10(—)	15(—)	13(—)
6	13(13)	19(22)	13(33)
8	13(—)	21(—)	13(—)
10	13.5(15)	22(24)	13(36)
12	17(—)	26.5(—)	15.5(—)
16	21(20)	29.5(32)	16.5(30)
20	25(26)	36(40)	19.5(36)

( ) : Dimensions of the CU series cylinders

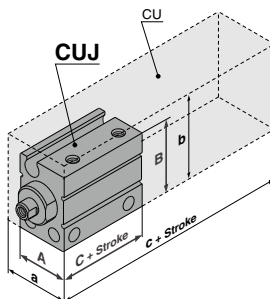

Ø4, Ø6, Ø8, Ø10

### Concentrates wiring and piping on one side

Allows more efficient installation, since four directions can be used freely.

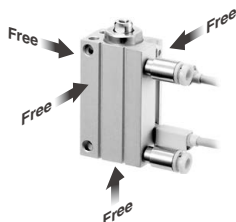

### Allows installation from four directions.

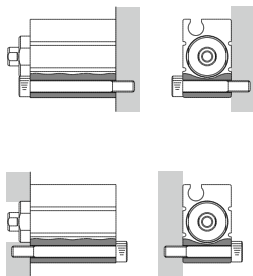

Ø12, Ø16, Ø20

### With counterbore for mounting

2 kinds of bodies are available. There is no protrusion for a mounting bolt.

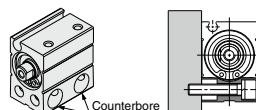

Lateral mounting body/CUJB

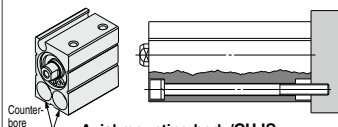

Axial mounting body/CUJS

# CUJ Series $\varnothing 4, \varnothing 6, \varnothing 8, \varnothing 10, \varnothing 12, \varnothing 16, \varnothing 20$

Two auto switches can be installed even for a 4 mm stroke.\*

\*  $\varnothing 12$  to  $\varnothing 20$  are available starting from a 5 mm stroke.

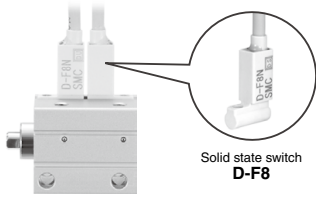

Solid state switch  
D-F8

## Easy seal replacement

Seals can be replaced easily by just removing the rod cover ( $\varnothing 4$  to  $\varnothing 10$ ) or retaining ring ( $\varnothing 12$  to  $\varnothing 20$ ).

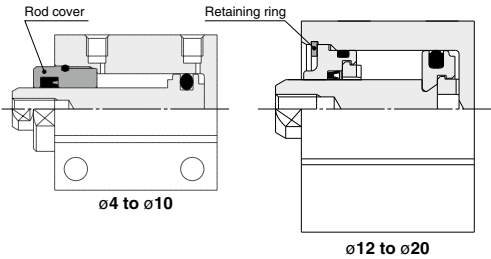

$\varnothing 4$  to  $\varnothing 10$

$\varnothing 12$  to  $\varnothing 20$

## $\varnothing 4, \varnothing 6, \varnothing 8, \varnothing 10$

### With boss (h9)

Centering can be done easily.

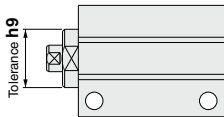

### Clean room compliant Clean Series (except $\varnothing 4$ )

## CUJ Series 10-11-

(Refer to pages 703 and 712.)

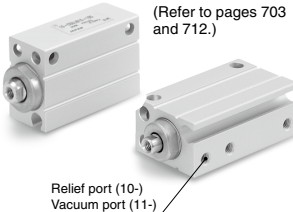

Relief port (10-)  
Vacuum port (11-)

## $\varnothing 12, \varnothing 16, \varnothing 20$

### Standard equipment with damper

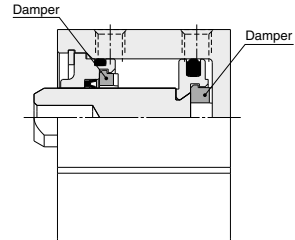

Damper

Damper

## RoHS compliant

## Applications

### Short pitch mounting is possible.

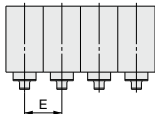

Pitch Dimensions  
(Without Magnet) (mm)

Bore size	E
4	10 Note 1)
6	13 Note 1)
8	13 Note 1)
10	13.5 Note 1)
12	17
16	21
20	25

Note 1) Body width dimensions have plus tolerances, so E dimensions should also be designed for plus tolerances. ( $\varnothing 4$  to  $\varnothing 10$  only)

Note 2) Refer to page 717 for built-in magnet.

### Lowering the center of gravity when using an external guide

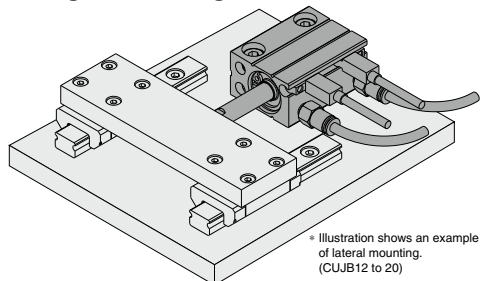

\* Illustration shows an example of lateral mounting. (CUJB12 to 20)

# Mini Free Mount Cylinder

# CUJ Series

ø4, ø6, ø8, ø10



## How to Order

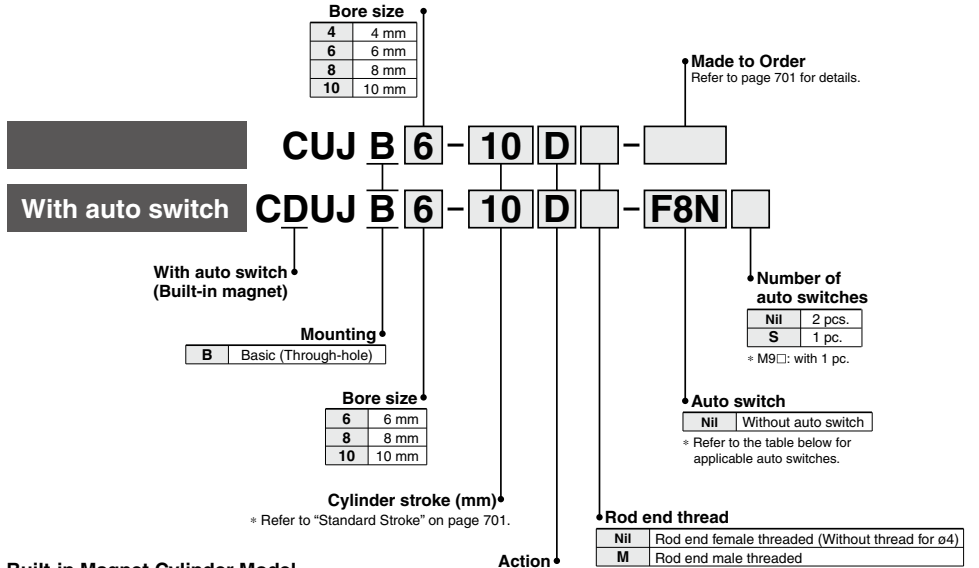

### Built-in Magnet Cylinder Model

In the case of built-in magnet without auto switch, the symbol for auto switch is "Nil".  
(Example) CDUJB8-15DM

### Applicable Auto Switches

Refer to pages 1271 through to 1365 for additional information on auto switches.

Type	Special function	Electrical entry	Indicator light	Wiring (Output)	Load voltage		Auto switch model		Lead wire length (m) *			Pre-wired connector	Applicable load						
					DC	AC	Perpendicular	In-line	0.5 (Nil)	1 (M)	3 (L)		5 (Z)	IC circuit	Relay, PLC				
																M9N	F8N	M9P	F8P
Solid state auto switch	—	Grommet	Yes	3-wire (NPN)	5 V, 12 V	—	—	—	●	●	●	○	○	IC circuit					
				3-wire (PNP)			—	—	●	●	●	○	○						
				2-wire	12 V	—	—	●	●	●	○	○	—			—			
				3-wire (NPN)	24 V	5 V, 12 V	—	—	●	●	●	○	○			○	○	IC circuit	
				3-wire (PNP)			—	—	●	●	●	○	○			○	○	IC circuit	
				2-wire	12 V	—	—	●	●	●	○	○	○			○	—		
	Diagnostic indication (2-color indicator)	Grommet	Yes	3-wire (NPN)	5 V, 12 V	—	—	—	●	●	●	○	○	○	IC circuit				
				3-wire (PNP)			—	—	●	●	●	○	○	○					
				2-wire	12 V	—	—	●	●	●	○	○	○	○			—		
				3-wire (NPN)	5 V, 12 V	—	—	—	○	○	●	●	●	○			○	IC circuit	
				3-wire (PNP)			—	—	○	○	●	●	●	○			○	○	
				2-wire	12 V	—	—	○	○	●	●	●	○	○			○	—	
Water resistant (2-color indicator)	Grommet	Yes	3-wire (NPN)	5 V, 12 V	—	—	—	○	○	○	○	○	○	IC circuit					
			3-wire (PNP)			—	—	○	○	○	○	○	○			○	○		
2-wire	12 V	—	—	○	○	○	○	○	○	○	○	○	—						

\*\* Water resistant type auto switches can be mounted on the above models, but in such case SMC cannot guarantee water resistance. Consult with SMC regarding water resistant types with the above model numbers.

\* Lead wire length symbols: 0.5 m ..... Nil (Example) M9N  
1 m ..... M (Example) M9NM  
3 m ..... L (Example) M9NL  
5 m ..... Z (Example) M9NZ

\* Auto switches marked with "○" are produced upon receipt of order.

Note 1) For 2-color indicator, use caution on hysteresis. Refer to page 1281, "Auto Switch Hysteresis" prior to use.

Note 2) Refer to pages 1271 through to 1365 for detailed auto switch specifications.

\* Auto switches are included, (but not assembled).

## Specifications

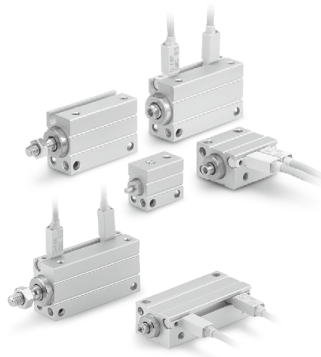

Bore size (mm)		4	6	8	10
<b>Action</b>		Double acting; Single acting, spring return			
<b>Fluid</b>		Air			
<b>Proof pressure</b>		1.05 MPa			
<b>Minimum operating pressure</b>	Double acting	0.15 MPa			0.1 MPa
	Single acting, spring return	0.35 MPa	0.3 MPa		0.2 MPa
<b>Maximum operating pressure</b>		0.7 MPa			
<b>Ambient and fluid temperature</b>		Without auto switch: -10 to 70°C (No freezing) With auto switch: -10 to 60°C (No freezing)			
<b>Cushion</b>		None			
<b>Lubrication</b>		Non-lube			
<b>Piston speed</b>		50 to 500 mm/s			
<b>Stroke length tolerance</b>		+0.5			
<b>Mounting</b>		Through-hole			

## Theoretical Output: Double Acting

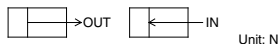

Bore size (mm)	Rod size (mm)	Operating direction	Piston area (mm <sup>2</sup> )	Operating pressure (MPa)		
				0.3	0.5	0.7
4	2	OUT	12.6	3.76	6.28	8.79
		IN	9.4	2.82	4.71	6.59
6	4	OUT	28.3	8.48	14.13	19.79
		IN	15.7	4.71	7.85	10.99
8	5	OUT	50.3	15.07	25.13	35.18
		IN	30.6	9.18	15.31	21.44
10	6	OUT	78.5	23.56	39.26	54.97
		IN	50.3	15.07	25.13	35.18

### Symbol

Double acting, single rod, without cushion

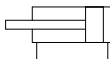

Single acting, spring return

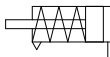

### Standard Stroke

Action	Bore size (mm)	Standard stroke (mm)
Double acting	4	4, 6, 8, 10, 15, 20
	6	4, 6, 8, 10, 15, 20
	8, 10	25, 30
Single acting, spring return	4	4, 6
	6	4, 6, 8
	8, 10	4, 6, 8, 10

## Spring Reaction Force: Single Acting, Spring Return

Spring in pre-loaded condition



When the spring is set in the cylinder.

Spring in loaded condition



When the spring is contracted by applying air.

Bore size (mm)	Spring condition	Stroke (mm)			
		4	6	8	10
4	Pre-loaded	1.70	1.27	—	—
	Loaded	2.55	2.55	—	—
6	Pre-loaded	2.45	2.01	1.57	—
	Loaded	3.33	3.33	3.33	—
8	Pre-loaded	4.67	3.76	2.86	1.96
	Loaded	6.47	6.47	6.47	6.47
10	Pre-loaded	5.04	4.18	3.31	2.45
	Loaded	6.77	6.77	6.77	6.77



Made to Order

[Click here for details](#)

Symbol	Contents
-XA□	Change of Rod End Shape <small>Note 1)</small>
-XB6	Heat resistant cylinder (-10 to 150°C) <small>Note 1)</small>
-XC22	Fluororubber seals <small>Note 2)</small>

Note1) Except models with auto switch and single-acting, spring return type  
Except bore size 4

Note2) Except single acting, spring return type and bore size 4

### Moisture Control Tube IDK Series



When operating an actuator with a small diameter and a short stroke at a high frequency, the dew condensation (water droplet) may occur inside the piping depending on the conditions.

Simply connecting the moisture control tube to the actuator will prevent dew condensation from occurring. For details, refer to the [Web Catalog](#).

## Weight: Double Acting

Bore size (mm)	Standard stroke (mm)							Additional weight		
	4	6	8	10	15	20	25	30	Built-in magnet	Rod end male threaded
<b>CUJB4</b>	7.2	7.9	8.6	9.3	11.1	12.8	—	—	—	0.4
<b>CUJB6</b>	12.4	13.6	14.8	16.0	18.9	21.8	24.7	27.6	2.7	0.8
<b>CUJB8</b>	15.6	17.0	18.4	19.7	23.0	26.4	29.9	33.4	3.0	1.5
<b>CUJB10</b>	17.9	19.4	20.8	22.3	25.9	29.5	33.1	36.7	3.2	2.6

## Weight: Single Acting, Spring Return

Bore size (mm)	Standard stroke (mm)				Additional weight	
	4	6	8	10	Built-in magnet	Rod end male threaded
<b>CUJB4</b>	7.2	7.9	—	—	—	0.4
<b>CUJB6</b>	12.8	14.0	15.2	—	2.4	0.8
<b>CUJB8</b>	15.8	17.2	18.6	19.9	2.5	1.5
<b>CUJB10</b>	17.9	19.4	20.8	22.3	2.4	2.6

# CUJ Series

## Mounting

How to Mount: Through-hole mounting bolts are available.

How to Order: Add the "CUJ-" in front of the bolts to be used.

Example) CUJ-M3 x 27 L

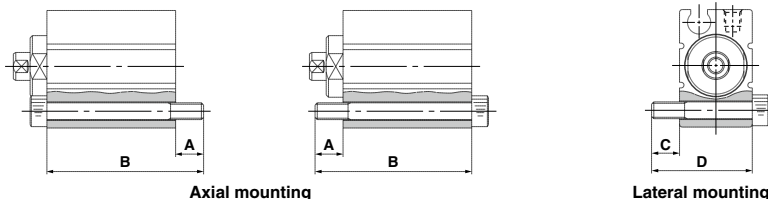

### Without Auto Switch (Without Magnet)

#### For Axial Mounting

Cylinder model	A	B	Mounting bolt size
<b>CUJB4-4</b>	4	21	M2.5 x 21 L
-6		23	M2.5 x 23 L
-8		25	M2.5 x 25 L
-10		27	M2.5 x 27 L
-15		32	M2.5 x 32 L
-20		37	M2.5 x 37 L <small>Note</small>
<b>CUJB6-4</b>	5	22	M3 x 22 L
-6		24	M3 x 24 L
-8		26	M3 x 26 L
-10		28	M3 x 28 L
-15		33	M3 x 33 L
-20		38	M3 x 38 L
-25	43	M3 x 43 L	
-30	48	M3 x 48 L	
<b>CUJB8-4</b>	5	22	M3 x 22 L
-6		24	M3 x 24 L
-8		26	M3 x 26 L
-10		28	M3 x 28 L
-15		33	M3 x 33 L
-20		38	M3 x 38 L
-25	43	M3 x 43 L	
-30	48	M3 x 48 L	
<b>CUJB10-4</b>	5	22	M3 x 22 L
-6		24	M3 x 24 L
-8		26	M3 x 26 L
-10		28	M3 x 28 L
-15		33	M3 x 33 L
-20		38	M3 x 38 L
-25	43	M3 x 43 L	
-30	48	M3 x 48 L	

Note) Only M2.5 x 37 L is made of stainless steel. Others are made of structural steel.

#### For Lateral Mounting

Cylinder model	C	D	Mounting bolt size
<b>CUJB4-4</b>	4	14	M2.5 x 14 L
-6			
-8			
-10			
-15			
-20			
<b>CUJB6-4</b>	5	18	M3 x 18 L
-6			
-8			
-10			
-15			
-20			
-25			
-30			
<b>CUJB8-4</b>	5	18	M3 x 18 L
-6			
-8			
-10			
-15			
-20			
-25			
-30			
<b>CUJB10-4</b>	5	18	M3 x 18 L
-6			
-8			
-10			
-15			
-20			
-25			
-30			

### With Auto Switch (Built-in Magnet)

#### For Axial Mounting

Cylinder model	A	B	Mounting bolt size
<b>CDUJB6-4</b>	5	27	M3 x 27 L
-6		29	M3 x 29 L
-8		31	M3 x 31 L
-10		33	M3 x 33 L
-15		38	M3 x 38 L
-20		43	M3 x 43 L
-25	48	M3 x 48 L	
-30	53	M3 x 53 L	
<b>CDUJB8-4</b>	5	27	M3 x 27 L
-6		29	M3 x 29 L
-8		31	M3 x 31 L
-10		33	M3 x 33 L
-15		38	M3 x 38 L
-20		43	M3 x 43 L
-25	48	M3 x 48 L	
-30	53	M3 x 53 L	
<b>CDUJB10-4</b>	5	27	M3 x 27 L
-6		29	M3 x 29 L
-8		31	M3 x 31 L
-10		33	M3 x 33 L
-15		38	M3 x 38 L
-20		43	M3 x 43 L
-25	48	M3 x 48 L	
-30	53	M3 x 53 L	

#### For Lateral Mounting

Cylinder model	C	D	Mounting bolt size
<b>CDUJB6-4</b>	5	18	M3 x 18 L
-6			
-8			
-10			
-15			
-20			
-25			
-30			
<b>CDUJB8-4</b>	5	18	M3 x 18 L
-6			
-8			
-10			
-15			
-20			
-25			
-30			
<b>CDUJB10-4</b>	5	18	M3 x 18 L
-6			
-8			
-10			
-15			
-20			
-25			
-30			

## Clean Series

### How to Order

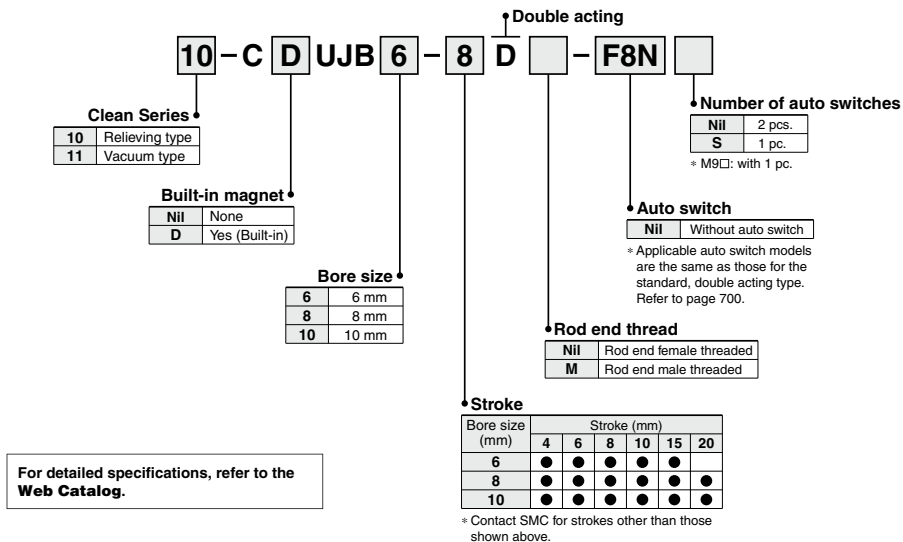

## Specifications

The specifications are the same as those for the standard, double acting type. Refer to page 701. However, the operating piston speed is ranged from 50 to 400 mm/s.

## Dimensions

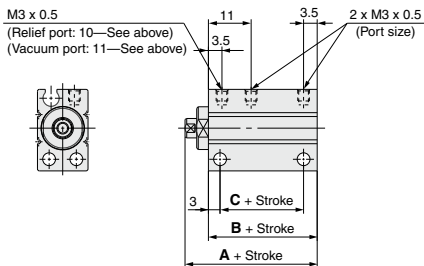

Bore size (mm)	Without auto switch			With auto switch		
	A	B	C	A	B	C
6, 8, 10	24	18	11.5	29	23	16.5

(mm)



## Construction

### Double Acting

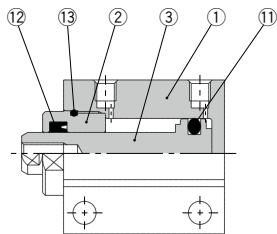

Without magnet

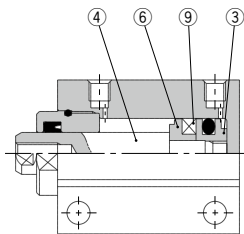

Built-in magnet

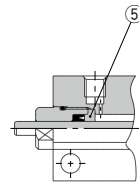

ø4

### Single Acting, Spring Return

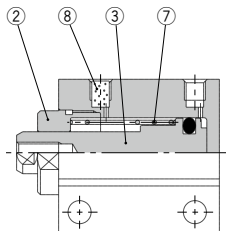

Without magnet

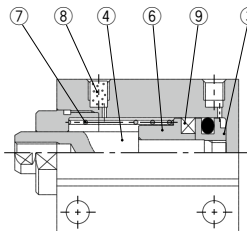

Built-in magnet

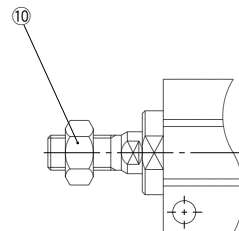

Rod end male threaded

### Component Parts

No.	Description	Material	Note
1	Cylinder tube	Aluminum alloy	Hard anodized
2	Rod cover	Copper alloy	Electroless nickel plated
3	Piston	Stainless steel	
	Without switch	Aluminum alloy	Chromated
4	Piston rod	Stainless steel	
5	Seal retainer	Aluminum alloy	Chromated (CUJB4 only)
6	Magnet retainer	Aluminum alloy	Chromated
7	Return spring	Piano wire	
8	Bronze element	Sintered metallic BC	
9	Magnet	—	
10	Rod end nut	Iron	Chromated
11	Piston seal	NBR	
12	Rod seal	NBR	
13	Tube gasket	NBR	

### Replacement Parts: Seal Kit Double Acting

Bore size (mm)	Kit no.	Contents
4	CUJB4-PS	Set of 11, 12, 13 and grease pack.
6	CUJB6-PS	
8	CUJB8-PS	
10	CUJB10-PS	

\* Seal kit 11 to 13 comes as a set. Use the kit number for each bore size.

### Single Acting, Spring Return

Bore size (mm)	Kit no.	Contents
4	CUJB4-S-PS	Set of 11 and grease pack.
6	CUJB6-S-PS	
8	CUJB8-S-PS	
10	CUJB10-S-PS	

\* Use the following part number for ordering a grease pack only.  
Grease part no.: GR-L-005 (5 g)



**Dimensions:  $\phi 4$  Double Acting; Single Acting, Spring Return**

Without Magnet: CUJB4

Note) The position of the width across flats may not be parallel to the cylinder tube.

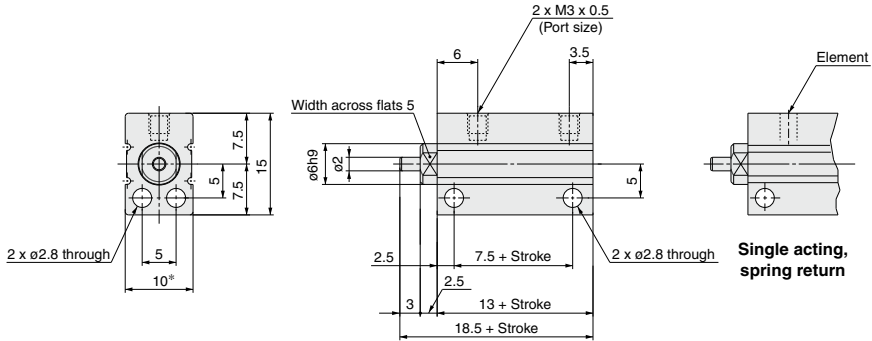

**Single acting,  
spring return**

**Rod end male threaded**

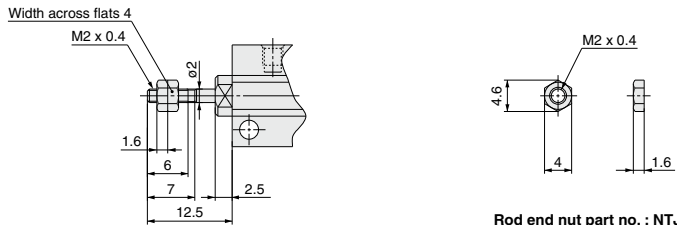

Rod end nut part no. : NTJ-004

\* Use caution especially when multiple cylinders are used in parallel such as stacking because the body width dimensions have plus tolerances.  
Contact SMC for a product with body width dimensions having different tolerances.

# CUJ Series

## Dimensions: $\phi 6$ Double Acting; Single Acting, Spring Return

### Without Magnet: CUJB6

Note) The position of the width across flats may not be parallel to the cylinder tube.

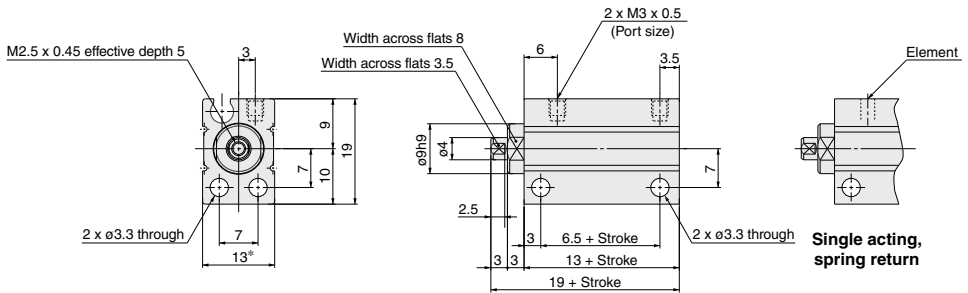

### Built-in Magnet: CDUJB6

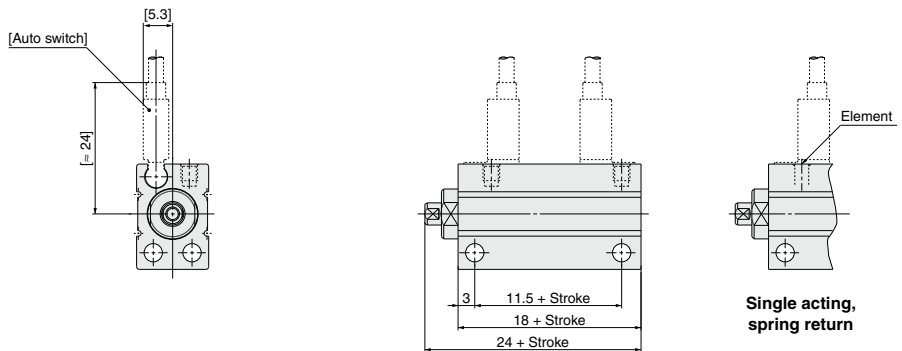

### Rod end male threaded

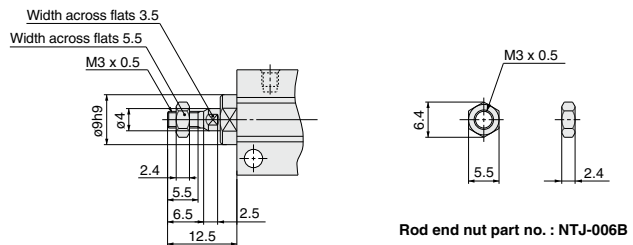

\* Use caution especially when multiple cylinders are used in parallel such as stacking because the body width dimensions have plus tolerances.  
Contact SMC for a product with body width dimensions having different tolerances.

**Dimensions:  $\phi 8$  Double Acting; Single Acting, Spring Return**

**Without Magnet: CUJB8**

Note) The position of the width across flats may not be parallel to the cylinder tube.

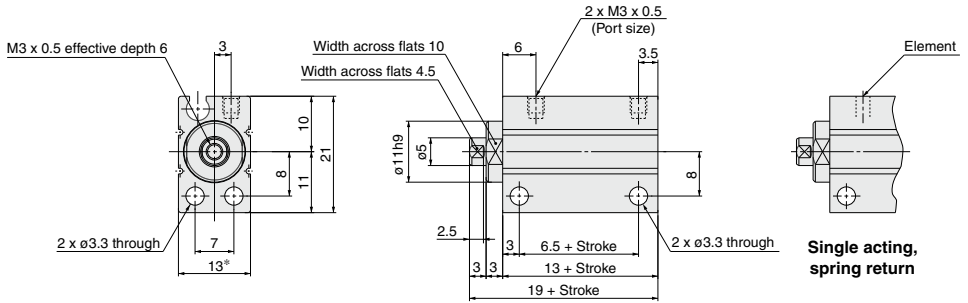

**Built-in Magnet: CDUJB8**

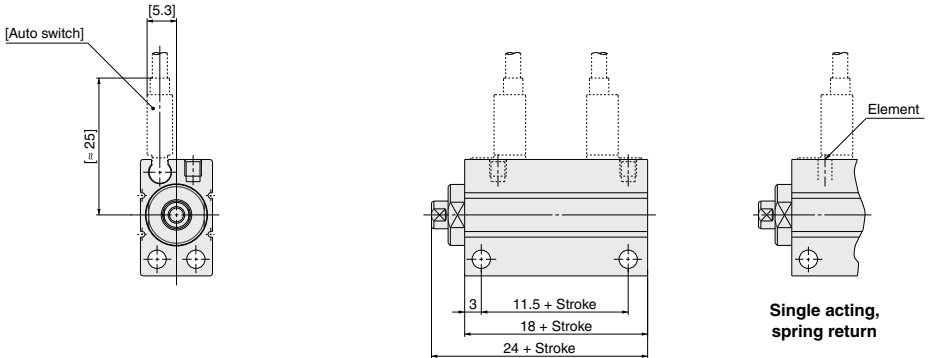

**Rod end male threaded**

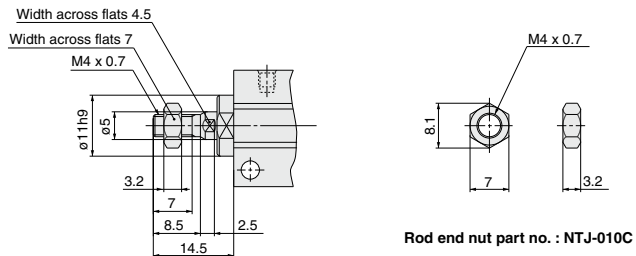

\* Use caution especially when multiple cylinders are used in parallel such as stacking because the body width dimensions have plus tolerances. Contact SMC for a product with body width dimensions having different tolerances.

# CUJ Series

## Dimensions: $\phi 10$ Double Acting; Single Acting, Spring Return

Without Magnet: CUJB10

Note) The position of the width across flats may not be parallel to the cylinder tube.

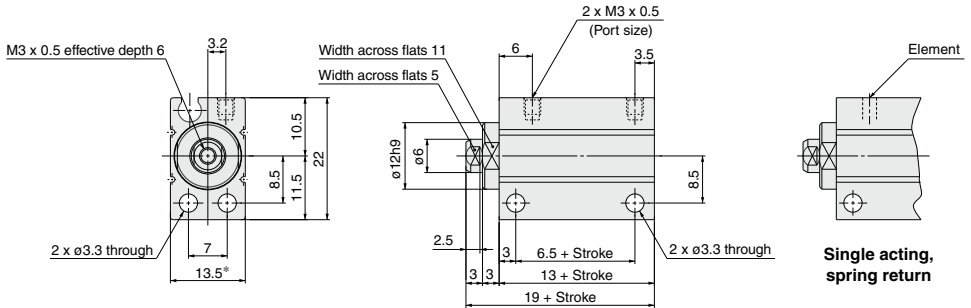

Built-in Magnet: CDUJB10

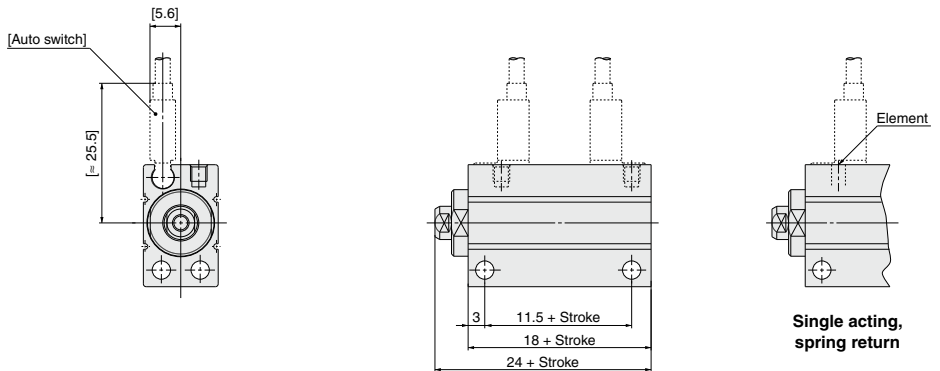

Rod end male threaded

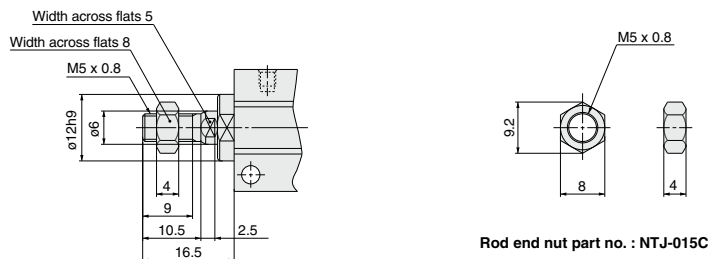

\* Use caution especially when multiple cylinders are used in parallel such as stacking because the body width dimensions have plus tolerances. Contact SMC for a product with body width dimensions having different tolerances.

# Mini Free Mount Cylinder

# CUJ Series

ø12, ø16, ø20



## How to Order

**CUJ B 12 - 30 D** - [ ] - [ ]

**With auto switch** **CDUJ B 12 - 30 D** - [ ] - **F8N** - [ ] - [ ]

**With auto switch (Built-in magnet)**

**Mounting direction**

**B** Lateral mounting  
 Counter-bore

**S** Axial mounting  
 Counter-bore

**Made to Order**  
Refer to page 710 for details.

**Auto switch**

Nil	2 pcs.
S	1 pc.

\* M9□: with 1 pc.

**Auto switch**

Nil	Without auto switch
-----	---------------------

\* Refer to the table below for applicable auto switches.

**Rod end thread**

Nil	Rod end female threaded
M	Rod end male threaded

**Action**

D	Double acting
S	Single acting, spring return

**Cylinder stroke (mm)**  
\* Refer to "Standard Stroke" on page 710.

**Built-in Magnet Cylinder Model**  
In the case of built-in magnet without auto switch, the symbol for auto switch is "Nil".  
(Example) CDUJB12-15DM

**Bore size**

12	12 mm
16	16 mm
20	20 mm

## Applicable Auto Switches

Refer to pages 1271 through to 1365 for additional information on auto switches.

Type	Special function	Electrical entry	Indicator light	Wiring (Output)	Load voltage		Auto switch model		Lead wire length (m) *			Pre-wired connector	Applicable load	
					DC	AC	Perpendicular	In-line	0.5 (Nil)	1 (M)	3 (L)			5 (Z)
									●	●	○			○
Solid state auto switch	—	Grommet	Yes	3-wire (NPN)	5 V, 12 V	—	—	M9N	●	●	○	○	IC circuit	Relay, PLC
				3-wire (PNP)			—	F8N	—	●	○	—		
				2-wire	12 V	—	—	M9P	●	●	○	○		
				3-wire (NPN)			—	F8P	—	●	○	—		
				3-wire (PNP)	24 V	—	—	M9B	●	●	○	○		
				2-wire			—	F8B	—	●	○	—		
	Diagnostic indication (2-color indicator)	Grommet	Yes	3-wire (NPN)	5 V, 12 V	—	—	M9NW	●	●	○	○	IC circuit	Relay, PLC
				3-wire (PNP)			—	M9PW	—	●	○	—		
				2-wire	12 V	—	—	M9BW	●	●	○	○		
				3-wire (NPN)			5 V, 12 V	—	M9NA**	○	○	●		
				3-wire (PNP)	12 V, 12 V	—	—	M9PA**	○	○	●	○		
				2-wire			12 V	—	M9BA**	○	○	●		

\*\* Water resistant type auto switches can be mounted on the above models, but in such case SMC cannot guarantee water resistance. Consult with SMC regarding water resistant types with the above model numbers.

\* Lead wire length symbols: 0.5 m ..... Nil (Example) M9N \* Auto switches marked with "○" are produced upon receipt of order.  
 1 m ..... M (Example) M9NM  
 3 m ..... L (Example) M9NL  
 5 m ..... Z (Example) M9NZ

Note 1) For 2-color indicator, use caution on hysteresis. Refer to page 1281, "Auto Switch Hysteresis" prior to use.

Note 2) Refer to pages 1271 through to 1365 for detailed auto switch specifications.

\* Auto switches are included, (but not assembled).



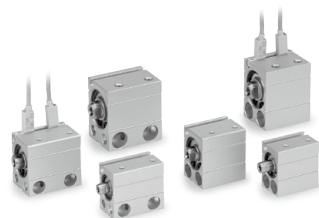

## Symbol

**Double acting, single rod, rubber bumper**

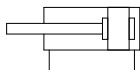

**Single acting, spring return, rubber bumper**

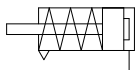

**Made to Order**

[Click here for details](#)

Symbol	Contents
-XA□	Change of Rod End Shape
-XB6	Heat resistant cylinder (-10 to 150°C) <small>Note 1)</small>
-XC22	Fluororubber seals <small>Note 2)</small>

Note 1) Except models with auto switch and single acting, spring return type.

Note 2) Excluding single acting, spring return type. A bumper is a standard product.

## Theoretical Output: Double Acting

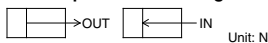

Bore size (mm)	Operating direction	Operating pressure MPa		
		0.3	0.5	0.7
12	OUT	34	57	79
	IN	25	42	59
16	OUT	60	101	141
	IN	45	75	106
20	OUT	94	157	220
	IN	71	118	165

## Moisture Control Tube IDK Series



When operating an actuator with a small diameter and a short stroke at a high frequency, the dew condensation (water droplet) may occur inside the piping depending on the conditions.

Simply connecting the moisture control tube to the actuator will prevent dew condensation from occurring. For details, refer to the [Web Catalog](#).

## Specifications

Bore size (mm)		12	16	20
<b>Action</b>		Double acting; Single acting, spring return		
<b>Fluid</b>		Air		
<b>Proof pressure</b>		1.05 MPa		
<b>Minimum operating pressure</b>	Double acting	0.07 MPa		0.05 MPa
	Single acting, spring return	0.25 MPa		0.18 MPa
<b>Maximum operating pressure</b>		0.7 MPa		
<b>Ambient and fluid temperature</b>		Without auto switch: -10 to 70°C (No freezing) With auto switch: -10 to 60°C (No freezing)		
<b>Cushion</b>		Rubber bumper		
<b>Lubrication</b>		Non-lube		
<b>Piston speed</b>		50 to 500 mm/s*		
<b>Stroke length tolerance</b>		+1.0 0		
<b>Mounting</b>		CUJB: Through-hole (lateral, axial direction: 2 locations each) CUJS: Through-hole (axial direction: 2 locations)		

\* Depending on the circuit condition, the piston speed may not reach the maximum speed.

## Standard Stroke

Bore size (mm)	Operating direction	Standard stroke (mm)
12	Double acting	5, 10, 15, 20, 25, 30, 35, 40, 45, 50
16		5, 10, 15, 20, 25, 30, 35, 40, 45, 50
20		
12	Single acting, spring return	5, 10
16		5, 10
20		

## Spring Reaction Force: Single Acting, Spring Return

**Spring in pre-loaded condition**

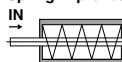

When the spring is set in the cylinder.

**Spring in loaded condition**

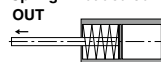

When the spring is contracted by applying air. Unit: N

Bore size (mm)	Spring condition	Stroke (mm)	
		5	10
12	Pre-loaded	6	3.5
	Loaded	9.5	9.5
16	Pre-loaded	7.5	4.5
	Loaded	11	11
20	Pre-loaded	10.5	5.5
	Loaded	16.5	16.5

\* Moving the load with the thrust (spring response) on the spring return side will cause poor stroke.

## Weight

### Double acting

Bore size (mm)	Standard stroke (mm)										Additional weight	
	5	10	15	20	25	30	35	40	45	50	Built-in magnet	Rod end male threaded
CUJ□12	21	26	31	35	40	45	50	55	60	65	6	4
CUJ□16	32	39	46	53	60	67	74	81	88	95	9	8
CUJ□20	52	62	72	82	92	102	112	122	132	142	12	13

### Single acting, Spring return

Bore size (mm)	Standard stroke (mm)		Additional weight	
	5	10	Built-in magnet	Rod end male threaded
CUJ□12	23	28	6	4
CUJ□16	34	41	9	8
CUJ□20	53	63	11	13

## Mounting

**How to Mount:** Through-hole mounting bolts are available.

**How to Order:** Add the "CUJB-" in front of the bolts to be used.

**Example) CUJB-M5 x 30 L**  
(For CUJS20-5)

\* The order number at above includes one mounting bolt and one spring washer.

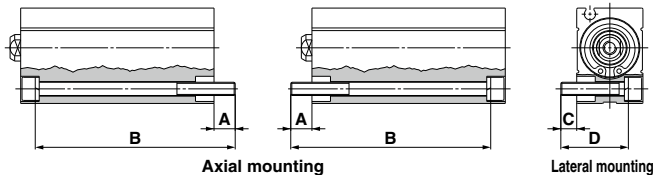

\* When mounting the cylinder, be sure to use the included spring washer.

### Without Auto Switch (Without Magnet)

#### For Axial Mounting

Material: Structural steel

Cylinder model	A	B	Mounting bolt size
<b>CUJS12-5</b>			
-10	8.5	25	M4 x 25 L
-15		30	M4 x 30 L
-20		35	M4 x 35 L
-25		40	M4 x 40 L
-30		45	M4 x 45 L
-35		50	M4 x 50 L
-40		55	M4 x 55 L
-45		60	M4 x 60 L
-50		65	M4 x 65 L
-50		70	M4 x 70 L
<b>CUJS16-5</b>			
-10	7.5	25	M4 x 25 L
-15		30	M4 x 30 L
-20		35	M4 x 35 L
-25		40	M4 x 40 L
-30		45	M4 x 45 L
-35		50	M4 x 50 L
-40		55	M4 x 55 L
-45		60	M4 x 60 L
-50		65	M4 x 65 L
-50		70	M4 x 70 L
<b>CUJS20-5</b>			
-10	10.5	30	M5 x 30 L
-15		35	M5 x 35 L
-20		40	M5 x 40 L
-25		45	M5 x 45 L
-30		50	M5 x 50 L
-35		55	M5 x 55 L
-40		60	M5 x 60 L
-45		65	M5 x 65 L
-50		70	M5 x 70 L
-50		75	M5 x 75 L

#### For Lateral Mounting

Material: Structural steel

Cylinder model	C	D	Mounting bolt size
<b>CUJB12-5</b>			
-10	8.5	20	M4 x 20 L
-15			
-20			
-25			
-30			
-35			
-40			
-45			
-50			
<b>CUJB16-5</b>			
-10	9.5	25	M4 x 25 L
-15			
-20			
-25			
-30			
-35			
-40			
-45			
-50			
<b>CUJB20-5</b>			
-10	7.5	25	M5 x 25 L
-15			
-20			
-25			
-30			
-35			
-40			
-45			
-50			

### With Auto Switch (Built-in Magnet)

#### For Axial Mounting

Material: Structural steel

Cylinder model	A	B	Mounting bolt size
<b>CDUJS12-5</b>			
-10	9.5	30	M4 x 30 L
-15		35	M4 x 35 L
-20		40	M4 x 40 L
-25		45	M4 x 45 L
-30		50	M4 x 50 L
-35		55	M4 x 55 L
-40		60	M4 x 60 L
-45		65	M4 x 65 L
-50		70	M4 x 70 L
-50		75	M4 x 75 L
<b>CDUJS16-5</b>			
-10	8	30	M4 x 30 L
-15		35	M4 x 35 L
-20		40	M4 x 40 L
-25		45	M4 x 45 L
-30		50	M4 x 50 L
-35		55	M4 x 55 L
-40		60	M4 x 60 L
-45		65	M4 x 65 L
-50		70	M4 x 70 L
-50		75	M4 x 75 L
<b>CDUJS20-5</b>			
-10	11.5	35	M5 x 35 L
-15		40	M5 x 40 L
-20		45	M5 x 45 L
-25		50	M5 x 50 L
-30		55	M5 x 55 L
-35		60	M5 x 60 L
-40		65	M5 x 65 L
-45		70	M5 x 70 L
-50		75	M5 x 75 L
-50		80	M5 x 80 L

#### For Lateral Mounting

Material: Structural steel

Cylinder model	C	D	Mounting bolt size
<b>CDUJB12-5</b>			
-10	8.5	20	M4 x 20 L
-15			
-20			
-25			
-30			
-35			
-40			
-45			
-50			
<b>CDUJB16-5</b>			
-10	9.5	25	M4 x 25 L
-15			
-20			
-25			
-30			
-35			
-40			
-45			
-50			
<b>CDUJB20-5</b>			
-10	7.5	25	M5 x 25 L
-15			
-20			
-25			
-30			
-35			
-40			
-45			
-50			

## ■ Clean Series

### How to Order

Double acting

**10 - C D UJ B 12 - 30 D - F8N**

**Clean Series**

10	Relieving type
11	Vacuum type

**Built-in magnet**

Nil	None
D	Yes (Built-in)

**Bore size**

12	12 mm
16	16 mm
20	20 mm

**Number of auto switches**

Nil	2 pcs.
S	1 pc.

\* M9□: with 1 pc.

**Auto switch**

Nil	Without auto switch
-----	---------------------

\* Applicable auto switch models are the same as those for the standard, double acting type. Refer to page 709.

**Rod end thread**

Nil	Rod end female threaded
M	Rod end male threaded

**Stroke**

Bore size (mm)	Stroke (mm)									
	5	10	15	20	25	30	35	40	45	50
12	●	●	●	●	●	●	—	—	—	—
16	●	●	●	●	●	●	—	—	—	—
20	●	●	●	●	●	●	●	●	●	●

\* Contact SMC for strokes other than those shown above.

**Mounting direction**

**B** Lateral mounting

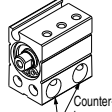

**S** Axial mounting

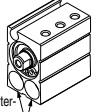

For detailed specifications, refer to the [Web Catalog](#).

## Specifications

The specifications are the same as those for the standard, double acting type. Refer to page 710. However, the operating piston speed is ranged from 50 to 400 mm/s.

## Dimensions

### Lateral mounting/C□UJB

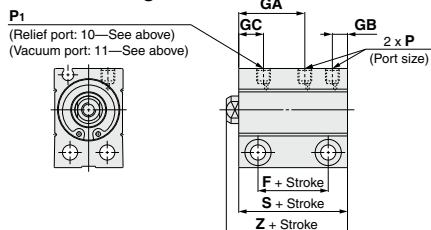

Bore size (mm)	Without magnet (mm)			
	F	GA	S	Z
12	11.5	15.5	23.5	27
16	13.5	17.5	25.5	29
20	15.5	18.5	29.5	34

Bore size (mm)	Built-in magnet (mm)			
	F	GA	S	Z
12	15.5	15.5	27.5	31
16	18	18	30	33.5
20	19.5	18.5	33.5	38

### Axial mounting/C□UJS

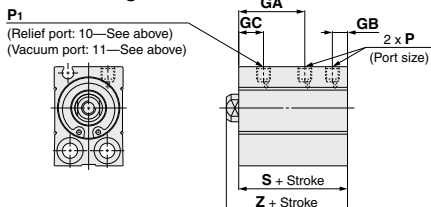

Bore size (mm)	(mm)			
	GC	GB	P <sub>1</sub>	P
12	7	4	M3 x 0.5	M3 x 0.5
16	8.5	4	M3 x 0.5	M3 x 0.5
20	8.5	5.5	M5 x 0.8	M5 x 0.8





## Construction

### Double Acting

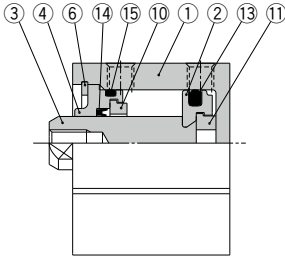

Without magnet

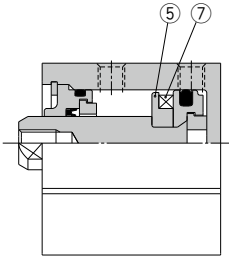

Built-in magnet

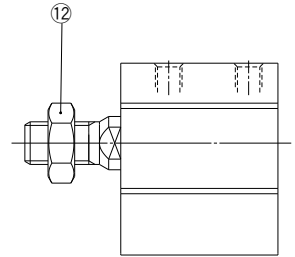

Rod end male threaded

### Single Acting, Spring Return

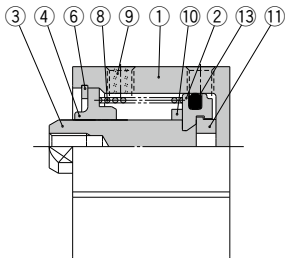

Without magnet

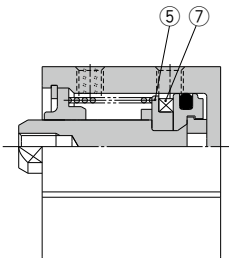

Built-in magnet

### Component Parts

No.	Description	Material	Note
1	Cylinder tube	Aluminum alloy	Hard anodized
2	Piston	Aluminum alloy	Trivalent chromated
3	Piston rod	Stainless steel	
4	Collar	Aluminum alloy	Hard anodized
5	Magnet holder	Aluminum alloy	Trivalent chromated
6	Retaining ring	Steel for special applications	Phosphate coated
7	Magnet	—	
8	Return spring	Steel wire	Zinc trivalent chromated
9	Element	Bronze casted (for ø12, ø16)	
	Plug with fixed restrictor	Structural steel	Nickel plated (for ø20)
10	Damper A	Resin	
11	Damper B	Resin	
12	Rod end nut	Steel wire	Chromated
13	Piston seal	NBR	
14	Rod seal	NBR	
15	O-ring	NBR	

### Replacement Parts: Seal Kit Double Acting

Bore size (mm)	Kit no.	Contents
12	CUJB12-PS	Set of 13, 14, 15 and grease pack.
16	CUJB16-PS	
20	CUJB20-PS	

\* Seal kit 13 to 15 comes as a set. Use the kit number for each bore size.

### Single Acting, Spring Return

Bore size (mm)	Kit no.	Contents
12	CUJB12-S-PS	Set of 13 and grease pack.
16	CUJB16-S-PS	
20	CUJB20-S-PS	

\* Use the following part number for ordering a grease pack only.  
Grease part no.: GR-L-005 (5 g)

# CUJ Series

## Dimensions: $\phi 12$ , $\phi 16$ , $\phi 20$ Double Acting; Single Acting, Spring Return

### Lateral Mounting Without Magnet: CUJB

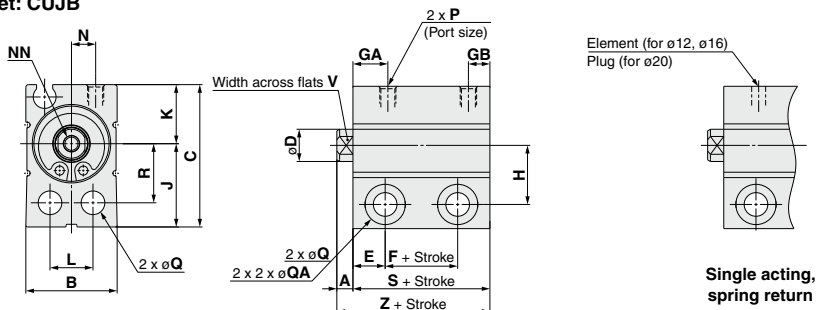

### Built-in Magnet: CDUJB

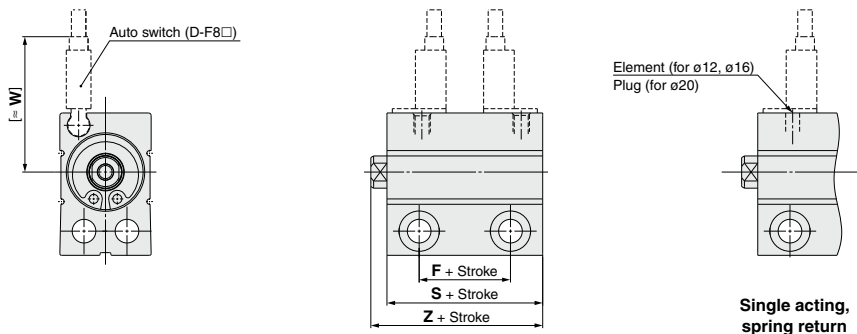

#### Rod end male threaded

#### Rod end nut

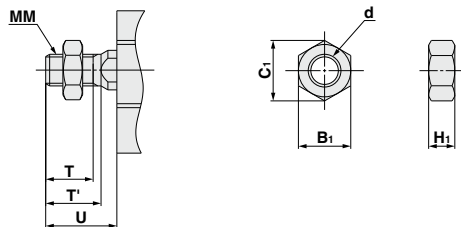

Part no.	Bore size (mm)	d	H <sub>1</sub>	B <sub>1</sub>	C <sub>1</sub>
NTJ-015C	12	M5 x 0.8	4	8	9.2
NT-015A	16	M6 x 1	5	10	11.5
NT-Q2	20	M8 x 1.25	5	13	15

Bore size (mm)												(mm)			
	A	B	C	D	E	GB	H	J	K	L	MM	NN	N	P	Q
12	3.5	17	26.5	6	6	4	11	15.5	11	8	M5 x 0.8	M3 x 0.5 effective depth of thread 6	3.5	M3 x 0.5	4.4 through
16	3.5	21	29.5	8	6	4	12.5	17	12.5	11.5	M6 x 1	M4 x 0.7 effective depth of thread 8	5.5	M3 x 0.5	4.4 through
20	4.5	25	36	10	7	5.5	15.5	21	15	13.5	M8 x 1.25	M5 x 0.8 effective depth of thread 7	7	M5 x 0.8	5.5 through

Bore size (mm)	QA	R	T	T'	U	V	W	Without magnet				Built-in magnet			
								F	GA	S	Z	F	GA	S	Z
12	7.5 depth, depth of counterbore 7	11	9	10.5	14	5	26	3.5 (5)	7.5	15.5 (17)	19 (20.5)	7.5 (9)	7.5	19.5 (21)	23 (24.5)
16	7.5 depth, depth of counterbore 7	12.5	10	12	15.5	6	27.5	4	8.5	16.5	20	8.5	9	21	24.5
20	9.5 depth, depth of counterbore 9	15.5	12	14	18.5	8	30	5.5	8.5	19.5	24	9.5	8.5	23.5	28

\* ( ) : Single acting, spring return

## Axial Mounting Without Magnet: CUJS

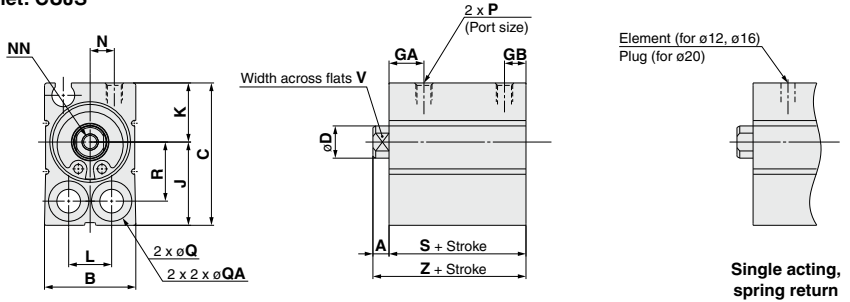

Single acting,  
spring return

## Built-in Magnet: CDUJS

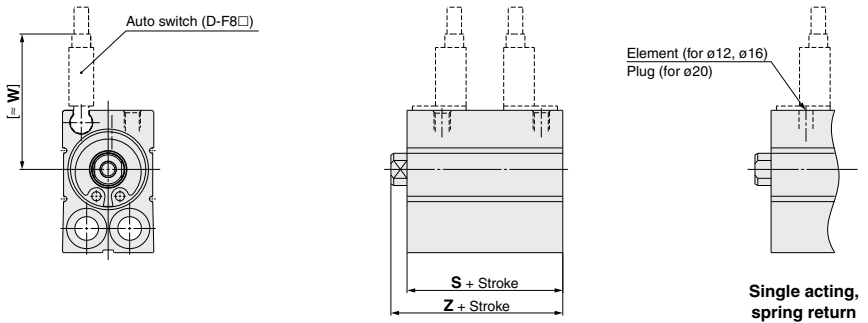

Single acting,  
spring return

### Rod end male threaded

### Rod end nut

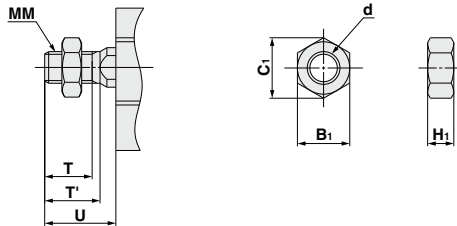

Part no.	Bore size (mm)	d	H <sub>1</sub>	B <sub>1</sub>	C <sub>1</sub>
NTJ-015C	12	M5 x 0.8	4	8	9.2
NT-015A	16	M6 x 1	5	10	11.5
NT-02	20	M8 x 1.25	5	13	15

Bore size (mm)	(mm)													
	A	B	C	D	GB	J	K	L	MM	NN	N	P	Q	QA
12	3.5	17	26.5	6	4	15.5	11	8	M5 x 0.8	M3 x 0.5 effective depth of thread 6	3.5	M3 x 0.5	4.4 through	7.5 depth, depth of counterbore 5.5
16	3.5	21	29.5	8	4	17	12.5	11.5	M6 x 1	M4 x 0.7 effective depth of thread 8	5.5	M3 x 0.5	4.4 through	7.5 depth, depth of counterbore 5.5
20	4.5	25	36	10	5.5	21	15	13.5	M8 x 1.25	M5 x 0.8 effective depth of thread 7	7	M5 x 0.8	5.5 through	9.5 depth, depth of counterbore 6.5

Bore size (mm)	R	T	T'	U	V	W	Without magnet			Built-in magnet		
							GA	S	Z	GA	S	Z
12	11	9	10.5	14	5	26	7.5	15.5 (17)	19 (20.5)	7.5	19.5 (21)	23 (24.5)
16	12.5	10	12	15.5	6	27.5	8.5	16.5	20	9	21	24.5
20	15.5	12	14	18.5	8	30	8.5	19.5	24	8.5	23.5	28

\* ( ) : Single acting, spring return

# Auto Switch Mounting

## Auto Switch: Proper Mounting Position (Detection at Stroke End)

D-F8□

D-M9□/M9□W/M9□A

• When detecting extended stroke end

• When detecting retracted stroke end

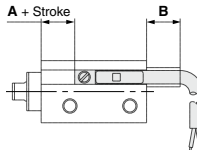
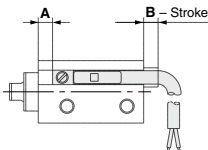
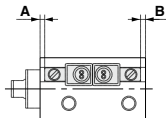

Bore size (mm)	D-F8□				D-M9□/M9□W D-M9□A				
	Double acting		Single acting		Double acting		Single acting		
	A	B	A	B	A	B	A	B	
6									
8	1	1	1	1	3	7	3	7	
10									
12	2	1	3.5	1	4	7	5.5	7	
16	3	1	3	1	5	6.5	5	6.5	
20	5	2	5	2	7	6	7	6	

Note 1) Solid state switch D-M9□/M9□W/M9□A: with 1 pc.

Note 2) Adjust the mounting position after confirming the auto switch operation.

## Auto Switch Mounting

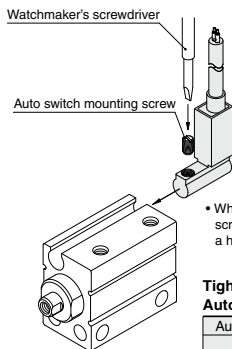

• When tightening an auto switch mounting screw, use a watchmaker's screwdriver with a handle of approx. 5 to 6 mm in diameter.

**Tightening Torque for Auto Switch Mounting Screw (N·m)**

Auto switch model	Tightening torque
D-F8□	0.10 to 0.20
D-M9□	0.05 to 0.15
D-M9□W	0.05 to 0.10
D-M9□A	0.05 to 0.10

## Operating Range

Auto switch model	Applicable bore size (mm)					
	6	8	10	12	16	20
D-F8□	2	2.5	2.5	3	4	4
D-M9□						
D-M9□W	3	3.5	3.5	4	4	5
D-M9□A						

\* This is a guideline including hysteresis, not meant to be guaranteed. (assuming approx. ±30% dispersion)  
This will vary substantially depending on the ambient environment.

## Caution on Proximity Installation

1. When cylinders with auto switches are adjacent to one another as shown in the figure below, provide a space between them of at least, the amount shown in the tables below.

If the space is not sufficient, the magnets in adjacent cylinders may cause the auto switches to malfunction.

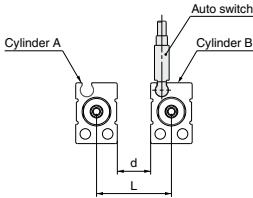

### Without Shielding Plate

Bore	ø6	ø8	ø10	ø12	ø16	ø20
L	19	19	19.5	21	25	29
d	6	6	6	4	4	4

### With Shielding Plate

Bore	ø6	ø8	ø10	ø12	ø16	ø20
L	16	13.5	14	18	22	26
d	3	0.5	0.5	1	1	1

- \* The space can be reduced by attaching a shielding plate (steel plate 0.2 to 0.3 mm thick) to the side of the cylinder. In the case of a ø6 bore size, be sure to attach the shielding plate on Cylinder A (on the surface opposite to the switch groove).

Shown below is the dimensions of the separately sold shielding plate (MU-S025) for reference.

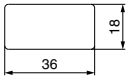

Material: Ferritic stainless steel, thickness: 0.3 mm  
Possible to attach this on the cylinder since the reverse side is treated with glue.

2. In the case of ø6 bore size cylinders with auto switches, keep the auto switch groove side surface at least 2.5 mm away from a magnetic substance.

If a magnetic material gets closer within 2.5 mm, the auto switches may malfunction due to a drop in magnetic force.

- \* If this surface is to be used for mounting, a spacer composed of a non-magnetic substance (aluminum, etc.) is required as shown in the figure below.

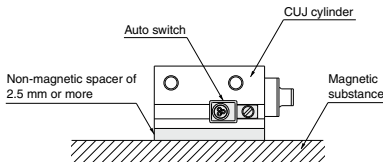



# CUJ Series Specific Product Precautions 1

Be sure to read this before handling the products. Refer to page 20 for safety instructions and pages 21 to 30 for actuator and auto switch precautions.

## Design

### Warning

Do not use an exhaust center. If its use cannot be avoided, use an lurching-prevention circuit, or consult SMC.

## Mounting

### Caution

- When mounting a mini free mount cylinder, tighten the bolts with the proper tightening torque.

Applicable bore size (mm)	Bolt	Proper tightening torque (N·m)*
4	M2.5 x 0.45	0.54 ±20% (0.432 to 0.648)
6	M3 x 0.5	1.06 ±20% (0.848 to 1.272)
8		
10		
12	M4 x 0.7	3.27 ±20% (2.61 to 3.92)
16		
20	M5 x 0.8	6.6 ±20% (5.28 to 7.92)

\* Torque coefficient: 0.2

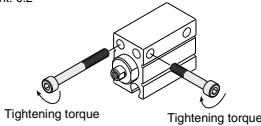

- Mounting the bolt from the rod side with a  $\phi 12$  to  $\phi 20$  lateral mounting body may result in interference with the workpiece. Use an axial mounting body.

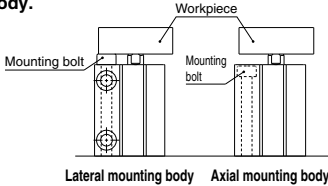

- Use caution especially when multiple cylinders are used in parallel such as stacking because the dimensions of the body's width have plus tolerances.

Contact us for information on a product with body width dimensions having different tolerances. ( $\phi 4$ ,  $\phi 6$ ,  $\phi 8$ ,  $\phi 10$  only)

- If the cylinder's mounting surface is not sufficiently flat, it may result in malfunction. We recommend that the cylinder's mounting surface flatness should be 1/100 mm or less.

- When mounting the product laterally, mount the product so that the entire surface on the cylinder side is in contact with the cylinder mounting plate.

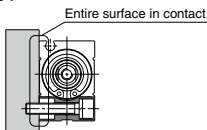

## Allowable Kinetic Energy

### Caution

When driving an inertial load, operate a cylinder with kinetic energy within the allowable value. The range in the chart below that is delineated by bold solid lines indicates the relationship between load mass and maximum driving speeds.

Bore size (mm)	4	6	8	10	12	16	20
Piston speed (m/s)	0.05 to 0.5						
Allowable kinetic energy (J)	$3.8 \times 10^{-3}$	$6.25 \times 10^{-3}$	$9.35 \times 10^{-3}$	$12.5 \times 10^{-3}$	0.030	0.053	0.077

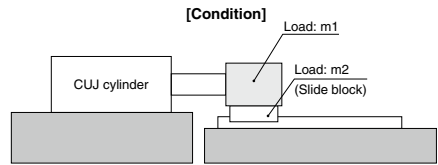
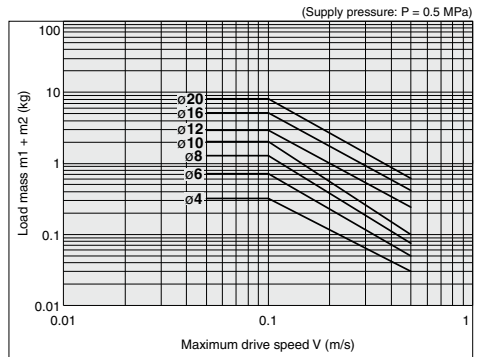

## Single Acting Cylinders

### Caution

- Do not move the load with the thrust (spring reaction force) on the cylinder retracting side. Otherwise, it will cause poor stroke or malfunction.
- Do not remove the element or plug.



# CUJ Series Specific Product Precautions 2

Be sure to read this before handling the products. Refer to page 20 for safety instructions and pages 21 to 30 for actuator and auto switch precautions.

## Selection

Strictly observe the limiting range of lateral load on a piston rod. (Refer to the graphs below.) If this product is used beyond the limits, it may shorten the machine life or cause damage.

### Double Acting, Female Threaded, Without Magnet (Without Auto Switch)

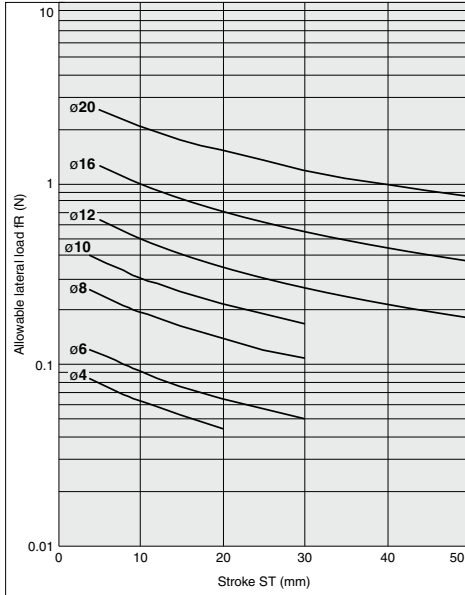

### Double Acting, Female Threaded, With Magnet (With Auto Switch)

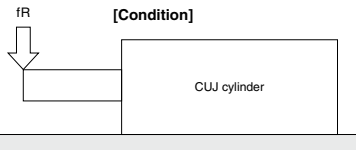
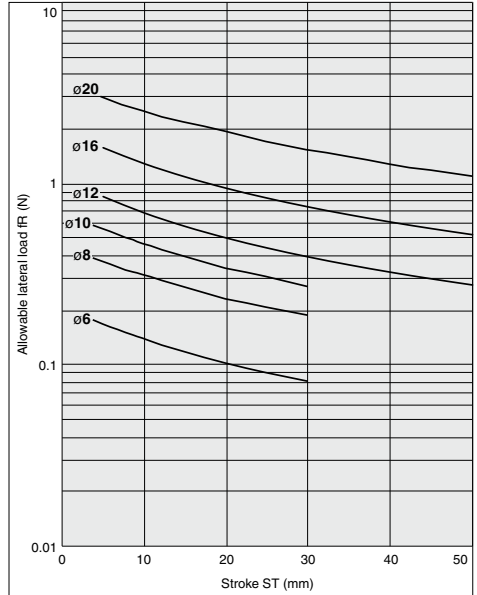

## ⚠ Caution

Adjust the cylinder drive speed by installing a speed controller, beginning at a low speed and gradually adjusting to the specified speed.

## Lubrication

## ⚠ Caution

### Lubrication to the non-lube type cylinders

Lubrication is not necessary since these cylinders are lubricated at the factory.

However, when you lubricate the cylinder, use synthetic oil (polyalphaolefin oil or equivalent). In that case, continue to lubricate the cylinder. Otherwise, loss of the initial lubricant may result in malfunction.

\* Oil lubrication is not possible with the clean series.



# CUJ Series

## Specific Product Precautions 3

Be sure to read this before handling the products. Refer to page 20 for safety instructions and pages 21 to 30 for actuator and auto switch precautions.

### Caution on Mounting Speed Controllers and Fittings

#### ⚠ Caution

Since the cylinder port size of M3 x 0.5 (M5 x 0.8 for  $\phi 20$  only) is used, use the cylinder series models listed below when connecting speed controllers and fittings directly to cylinders.

- After manually tightening speed controllers and fittings, tighten approximately a quarter turn (a 1/6 turn for  $\phi 20$  only) more using a tightening tool. In cases where there are gaskets in two places such as universal elbows, universal tees, etc., double the additional tightening to a half turn (a 1/3 turn for  $\phi 20$  only). If screws are tightened excessively, air leakage may result due to broken threads or a deformed gasket. If screws are tightened insufficiently, looseness and accompanying air leakage are likely to occur.

#### <Speed Controllers>

##### With Magnet (With Auto Switch)

Bore size (mm)	6, 8, 10	12, 16	20
Port size	M3 x 0.5		M5 x 0.8
Stroke (mm)	4 or more	5 or more	5 or more
AS12□1F-M3-02	●	●	—
AS12□1F-M5-02	—	—	●
AS12□1F-M3-23	○	●	—
AS12□1F-M5-23	—	—	●
AS12□1F-M3-04	○	●	—
AS12□1F-M5-04	—	—	●
AS12□1F-M5-06	—	—	●
AS13□1F-M3-23	○	●	—
AS13□1F-M3-04	○	●	—
AS13□1F-M5-23	—	—	●
AS13□1F-M5-04	—	—	●
AS13□1F-M5-06	—	—	●

- : Applicable to mounting condition 1, 2, 3 and 4.
- : Applicable to mounting condition 1 and 3.

##### Without Magnet (Without Auto Switch)

Bore size (mm)	4, 6, 8, 10			12, 16	20
Port size	M3 x 0.5				M5 x 0.8
Stroke (mm)	4	6	8 or more	5 or more	5 or more
AS12□1F-M3-02	○	○	○	●	—
AS12□1F-M5-02	—	—	—	—	●
AS12□1F-M3-23	—	○	○	●	—
AS12□1F-M5-23	—	—	—	—	●
AS12□1F-M3-04	—	—	○	●	—
AS12□1F-M5-04	—	—	—	—	●
AS12□1F-M5-06	—	—	—	—	●
AS13□1F-M3-23	—	○	○	●	—
AS13□1F-M3-04	—	—	○	●	—
AS13□1F-M5-23	—	—	—	—	●
AS13□1F-M5-04	—	—	—	—	●
AS13□1F-M5-06	—	—	—	—	●

- : Applicable to mounting condition 1, 2, 3 and 4.
- : Applicable to mounting condition 1 and 3.

Fig. (1)

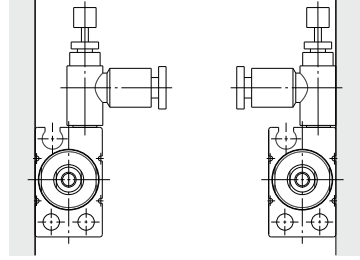

Mounting condition 1

Mounting condition 2

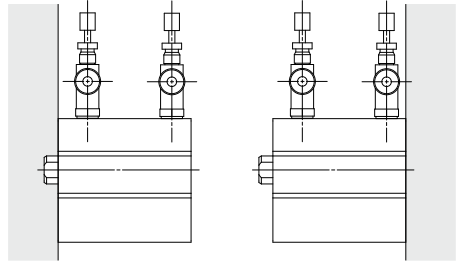

Mounting condition 3

Mounting condition 4





# CUJ Series Specific Product Precautions 4

Be sure to read this before handling the products. Refer to page 20 for safety instructions and pages 21 to 30 for actuator and auto switch precautions.

## Caution on Mounting Speed Controllers and Fittings

### <One-touch Fittings and Hose Nipples>

#### With Magnet (With Auto Switch)

Bore size (mm)		6, 8, 10			12, 16		20	
Port size		M3 x 0.5					M5 x 0.8	
Stroke (mm)		4	6 or more	5 or more	5	10 or more		
Male connector (with hexagon socket head)	KQ2S02-M3G	●	●	●	—	—		
	KQ2S23-M3G	●	●	●	—	—		
	KQ2S23-M5□	—	—	—	●	●		
	KQ2S04-M3G	△	△	●	—	—		
	KQ2S04-M5□	—	—	—	●	●		
Male connector	KQ2S06-M5□	—	—	—	●	●		
	KQ2H02-M3G	●	●	●	—	—		
	KQ2H02-M5□	—	—	—	●	●		
	KQ2H23-M3G	△	△	●	—	—		
	KQ2H23-M5□	—	—	—	●	●		
	KQ2H04-M3G	△	△	△	—	—		
	KQ2H04-M5□	—	—	—	●	●		
Barb fitting	KQ2H06-M5	—	—	—	△	△		
	M-3AU-3&4	●	●	●	—	—		
	M-3ALU-3&4	●	●	●	—	—		
	M-5AU-3&4&6	—	—	—	●	●		
M-5ALU-3&4&6	—	—	—	●	●			

● : Applicable to mounting condition 1, 2, 3 and 4.

○ : Applicable to mounting condition 1, 2 and 3.

△ : Applicable to mounting condition 1 and 3.

\* During actual operation, use the speed control device circuit.

#### Without Magnet (Without Auto Switch)

Bore size (mm)		4		6, 8, 10		12, 16		20		
Port size		M3 x 0.5					M5 x 0.8			
Stroke (mm)		4	6 or more	4	6 or more	5	10 or more	5	10 or more	
Male connector (with hexagon socket head)	KQ2S02-M3G	●	●	●	●	●	●	—	—	
	KQ2S23-M3G	●	●	●	●	●	●	—	—	
	KQ2S23-M5□	—	—	—	—	—	—	●	●	
	KQ2S04-M3G	—	○	—	△	●	●	—	—	
	KQ2S04-M5□	—	—	—	—	—	—	●	●	
Male connector	KQ2S06-M5□	—	—	—	—	—	—	●	●	
	KQ2H02-M3G	●	●	●	●	●	●	—	—	
	KQ2H02-M5□	—	—	—	—	—	—	●	●	
	KQ2H23-M3G	—	○	—	△	●	●	—	—	
	KQ2H23-M5□	—	—	—	—	—	—	●	●	
	KQ2H04-M3G	—	○	—	△	—	△	—	—	
	KQ2H04-M5□	—	—	—	—	—	—	●	●	
Male elbow	KQ2H06-M5	—	—	—	—	—	—	—	△	
	KQ2L02-M3G	●	●	●	●	●	●	—	—	
	KQ2L02-M5□	—	—	—	—	—	—	●	●	
	KQ2L23-M3G	—	○	—	△	●	●	—	—	
	KQ2L23-M5□	—	—	—	—	—	—	●	●	
	KQ2L04-M3G	—	○	—	△	●	●	—	—	
Barb fitting	KQ2L04-M5□	—	—	—	—	—	—	●	●	
	KQ2L06-M5□	—	—	—	—	—	—	●	●	
	M-3AU-3&4	●	●	●	●	●	●	—	—	
	M-5AU-3&4&6	—	—	—	—	—	—	●	●	
M-3ALU-3&4	●	●	●	●	●	●	—	—		
M-5ALU-3&4&6	—	—	—	—	—	—	●	●		

● : Applicable to mounting condition 1, 2, 3 and 4.

○ : Applicable to mounting condition 1, 2 and 3.

△ : Applicable to mounting condition 1 and 3.

\* During actual operation, use the speed control device circuit.

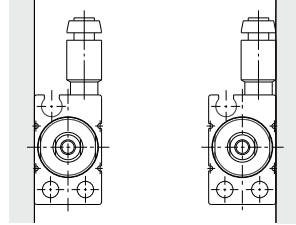

Mounting condition 1

Mounting condition 2

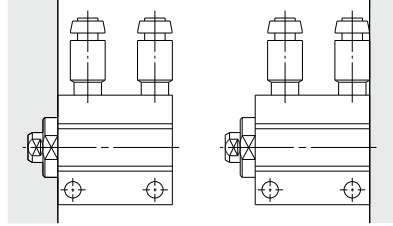

Mounting condition 3

Mounting condition 4

\* The above figures show the mounting conditions with the KJS One-touch fittings.

\*\* Refer to the [Web Catalog](#) for details One-touch fittings and hose nipples.